



# PRESTRESSED CONCRETE STANDARD



## APPLICATION

Designed to support:

- Masonry loads
- Uniformly distributed timber floor loads
- Uniformly distributed roof loads
- Concrete floor loads
- Attic truss loads
- Point loads: compound trusses, steel beams, etc

ALWAYS CHECK LOADINGS AGAINST OUR LOAD-SPAN TABLE

## INSTALLATION NOTES

For general installation notes please refer to page 67.

### Additional installation requirements for lintels supporting concrete floor units

- Check that the correct lintel has been installed.
- Minimum recommended lintel depth is 140mm in order to absorb the shock loading of concrete floor. Precast flooring units should be laid on a mortar bed across the whole wall width and should not be dragged over supports.

## ADVANTAGES

- A cost effective range of lintels, most of which are reversible
- Easy to install and suitable for a variety of applications: internal partitions, external cavity walls, garages, over services.
- We offer a wide range of lintels from 100 x 65 through to 215 x 140.
- If required, Stressline can schedule and deliver in house plots.

## IMPORTANT NOTES

- The loading figures published in the load-span tables represent the Uniform Distributed Serviceable Load (UDL) in kN/m which can be supported by the lintel without the provision of structural brickwork/blockwork over. This is known as Independent Design.
- Lintel lengths shown greyed out within the load-span table are available in longer lengths than the maximum clear span would normally allow. These longer lengths lintels should be used over a series of openings (with intermediate supports) NOT exceeding the maximum clear span and NOT simply supported at each end (i.e. all 65mm deep lintels must not clear span more than 1800mm).

## ABBREVIATIONS:

UDL – Uniform Distributed Load (Serviceable)  
 RM – Resistance Moment (Serviceable)



If in doubt please contact  
 our technical department on  
 01455 272457

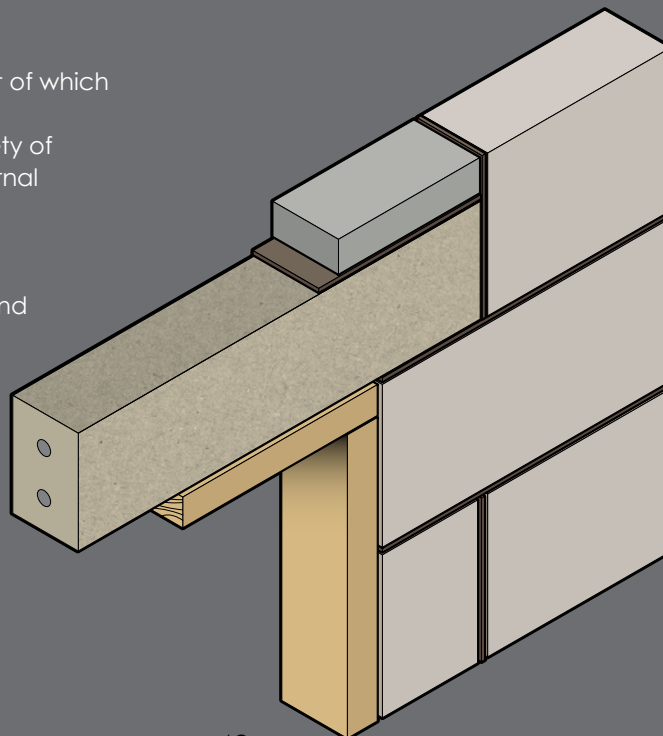

**65 x 100**

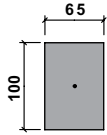

STANDARD LENGTHS (mm)	600	750	900	1050	1200	1350	1500	1650	1800	2100	2400	2700	3000	
Clear Span (mm)	300	450	600	750	900	1050	1200	1350	1500	1800				
Weight (kg/m)	15.3	15.3	15.3	15.3	15.3	15.3	15.3	15.3	15.3	15.3	15.3	15.3	15.3	
UDL (kN/m)	23.9*	23.9*	18.8*	12.4	8.7	6.5	5.0	3.9	3.2	2.2				
RM (kNm)	1.0	1.0	1.0	1.0	1.0	1.0	1.0	1.0	1.0	1.0				

\*UDL is restricted by shear  
Minimum manufactured length is 450mm    Maximum manufactured length is 3000mm

**100 x 65**

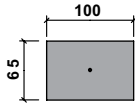

STANDARD LENGTHS (mm)	600	750	900	1050	1200	1350	1500	1650	1800	2100	2400	2700	3000	
Clear Span (mm)	300	450	600	750	900	1050	1200	1350	1500	1800				
Weight (kg/m)	15.3	15.3	15.3	15.3	15.3	15.3	15.3	15.3	15.3	15.3	15.3	15.3	15.3	
UDL (kN/m)	23.9*	23.9*	13.8*	8.9	6.5	5.3	4.1	3.2	2.6	1.8				
RM (kNm)	0.8	0.8	0.8	0.8	0.8	0.8	0.8	0.8	0.8	0.8				

\*UDL is restricted by shear  
Minimum manufactured length is 450mm    Maximum manufactured length is 3000mm

**R15A 100 x 140**

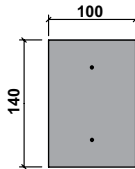

STANDARD LENGTHS (mm)	1050	1200	1350	1500	1650	1800	2100	2400	2700	3000	3300	3600	4050	4200
Clear Span (mm)	750	900	1050	1200	1350	1500	1800	2100	2400	2700	3000	3300	3600	3900
Weight (kg/m)	33.0	33.0	33.0	33.0	33.0	33.0	33.0	33.0	33.0	33.0	33.0	33.0	33.0	33.0
UDL (kN/m)	40.2*	28.2	21.8	17.0	13.6	11.1	7.8	5.7	4.4	3.4	2.7	2.2	1.8	1.5
RM (kNm)	3.7	3.7	3.7	3.7	3.7	3.7	3.7	3.7	3.7	3.7	3.7	3.7	3.7	3.7

\*UDL is restricted by shear  
Minimum manufactured length is 600mm    Maximum manufactured length is 4200mm

**R15 140 x 100**

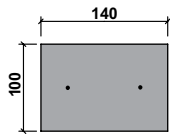

STANDARD LENGTHS (mm)	1050	1200	1350	1500	1650	1800	2100	2400	2700	3000	3300	3600	4050	4200
Clear Span (mm)	750	900	1050	1200	1350	1500	1800	2100	2400	2700	3000	3300	3600	3900
Weight (kg/m)	33.0	33.0	33.0	33.0	33.0	33.0	33.0	33.0	33.0	33.0	33.0	33.0	33.0	33.0
UDL (kN/m)	35.9*	26.3	19.3	14.8	11.8	9.5	6.6	4.8	3.6	2.8	2.2	1.8	1.5	1.2
RM (kNm)	3.0	3.0	3.0	3.0	3.0	3.0	3.0	3.0	3.0	3.0	3.0	3.0	3.0	3.0

\*UDL is restricted by shear  
Minimum manufactured length is 600mm    Maximum manufactured length is 4200mm

**R22A 100 x 215**

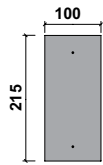

STANDARD LENGTHS (mm)	600	900	1200	1350	1500	1800	2100	2400	2700	3000	3300	3600	4050	4200
Clear Span (mm)	300	600	900	1050	1200	1500	1800	2100	2400	2700	3000	3300	3600	3900
Weight (kg/m)	51.7	51.7	51.7	51.7	51.7	51.7	51.7	51.7	51.7	51.7	51.7	51.7	51.7	51.7
UDL (kN/m)	67.6*	67.6*	51.4	44.5	35.3	23.7	17.0	12.7	9.8	7.8	6.5	5.2	4.3	3.6
RM (kNm)	8.7	8.7	8.7	8.7	8.7	8.7	8.7	8.7	8.7	8.7	8.7	8.7	8.7	8.7

\*UDL is restricted by shear  
Minimum manufactured length is 600mm    Maximum manufactured length is 4200mm

**R22 215 x 100**

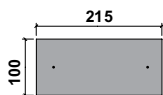

STANDARD LENGTHS (mm)	600	900	1200	1350	1500	1800	2100	2400	2700	3000	3300	3600	4050	4200
Clear Span (mm)	300	600	900	1050	1200	1500	1800	2100	2400	2700	3000	3300	3600	3900
Weight (kg/m)	51.7	51.7	51.7	51.7	51.7	51.7	51.7	51.7	51.7	51.7	51.7	51.7	51.7	51.7
UDL (kN/m)	49.0*	49.0*	26.0	19.3	14.8	9.4	6.5	4.7	3.5	2.7	2.1	1.6	1.3	1.0
RM (kNm)	3.0	3.0	3.0	3.0	3.0	3.0	3.0	3.0	3.0	3.0	3.0	3.0	3.0	3.0

\*UDL is restricted by shear  
Minimum manufactured length is 600mm    Maximum manufactured length is 4200mm

STANDARD LENGTHS (mm)	600	900	1050	1200	1350	1500	1800	2100	2400	2700	3000			
Clear Span (mm)	300	600	750	900	1050	1200	1500	1800						
Weight (kg/m)	22.2	22.2	22.2	22.2	22.2	22.2	22.2	22.2	22.2	22.2	22.2			
UDL (kN/m)	33.0*	18.8*	12.3	8.6	6.3	4.8	3.1	2.1						
RM (kNm)	1.0	1.0	1.0	1.0	1.0	1.0	1.0	1.0						

\*UDL is restricted by shear  
Minimum manufactured length is 600mm    Maximum manufactured length is 3000mm

### 140 x 65

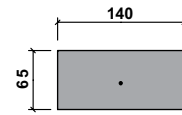

STANDARD LENGTHS (mm)	1200	1500	1800	2100	2400	2700	3000	3300	3600	4050	4200			
Clear Span (mm)	900	1200	1500	1800	2100	2400	2700	3000	3300	3600	3900			
Weight (kg/m)	48.0	48.0	48.0	48.0	48.0	48.0	48.0	48.0	48.0	48.0	48.0			
UDL (kN/m)	24.2*	13.9	9.0	6.2	4.5	3.3	2.6	2.0	1.6	1.3	1.0			
RM (kNm)	2.9	2.9	2.9	2.9	2.9	2.9	2.9	2.9	2.9	2.9	2.9			

\*UDL is restricted by shear  
Minimum manufactured length is 900mm    Maximum manufactured length is 4200mm

### 140 x 140

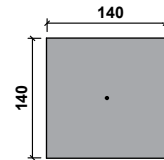

STANDARD LENGTHS (mm)	1200	1500	1800	2100	2400	2700	3000	3300	3600	4050	4200			
Clear Span (mm)	900	1200	1500	1800	2100	2400	2700	3000	3300	3600	3900			
Weight (kg/m)	73.7	73.7	73.7	73.7	73.7	73.7	73.7	73.7	73.7	73.7	73.7			
UDL (kN/m)	61.6*	37.6*	25.1	17.9	13.3	10.3	8.1	6.5	5.3	4.4	3.7			
RM (kNm)	9.2	9.2	9.2	9.2	9.2	9.2	9.2	9.2	9.2	9.2	9.2			

\*UDL is restricted by shear  
Minimum manufactured length is 900mm    Maximum manufactured length is 4200mm

### RW22A 140 x 215

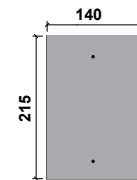

STANDARD LENGTHS (mm)	1200	1500	1800	2100	2400	2700	3000	3300	3600	4050	4200			
Clear Span (mm)	900	1200	1500	1800	2100	2400	2700	3000	3300	3600	3900			
Weight (kg/m)	73.7	73.7	73.7	73.7	73.7	73.7	73.7	73.7	73.7	73.7	73.7			
UDL (kN/m)	43.5*	25.1	16.2	11.2	8.1	6.1	4.7	3.7	2.9	2.4	1.9			
RM (kNm)	5.2	5.2	5.2	5.2	5.2	5.2	5.2	5.2	5.2	5.2	5.2			

\*UDL is restricted by shear  
Minimum manufactured length is 900mm    Maximum manufactured length is 4200mm

### RW22 215 x 140

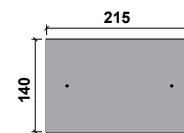

STANDARD LENGTHS (mm)	600	900	1050	1200	1500	1800	2100	2400	2700	3000				
Clear Span (mm)	300	600	750	900	1200	1500	1800							
Weight (kg/m)	35.0	35.0	35.0	35.0	35.0	35.0	35.0	35.0	35.0	35.0				
UDL (kN/m)	36.4*	36.4*	23.7	17.0	9.6	6.1	4.2							
RM (kNm)	1.9	1.9	1.9	1.9	1.9	1.9	1.9							

\*UDL is restricted by shear  
Minimum manufactured length is 600mm    Maximum manufactured length is 3000mm

### 215 x 65

